

ROXIE - 1166WW

ULTRA COMPACT - LED 300 W



- **Type:** Followspot
- **Source:** LED 300 W
- **Optics:** 10,5° to 22,5° zoom
- **Colour temperature:** Warm white

Followspot

The little LED wonder with the power punch

Roxie is Robert Juliat's first LED followspot. The compact 300W spot is all about efficiency. It fits in the smallest of spaces and is the ideal energy-efficient solution for all those venues where running costs need to be significantly reduced. Roxie delivers an output comparable to most of the 575W discharge followspot available on the market. No heat, no lamp change, less maintenance. Smooth electronic dimming is available as standard, either locally via the rotary dimmer knob or remotely via DMX.

Features

- **Fully closing iris:** removable for fast, easy replacement
- **Universal gobo holder:** a-size glass and metal gobo
- **Local control:** light intensity adjustment through built-in potentiometer
- **Internal glass filter holder:** long term use of durable coloured, dichroic or textured glass
- **Colour changer:** 6-way, 'push/pull' colour changer system for simultaneous use of multiple filters
- **DMX:** 8 or 16 bits dimming and strobe function
- **Parameters:** adjustable curves and response thru 4-button display with automatic light switch-off
- **Easy focus reference:** graduated scale on side of lantern; fast and easy refocusing

Optical

- **Very long-life lamp source:** 50 000 hours - Lumen maintenance greater than 70% after 50 000 hours
- **Variable zoom optics:** sharp focus at every beam angle
- **Electronic dimmer:** dimming without clipping or cut-out at low intensity levels; high quality smoothing
- **No colour shift:** colour temperature remains the same when dimming

Construction

- **Made in France :** fully manufactured in Robert Juliat premises retaining complete control over all aspects of quality
- **PSU:** built-in electronic flicker-free power supply for easy, plug-and-play installation
- **Power connectors:** neutriK® powerCON TRUE1 IN and OUT connectors for daisy chaining
- **Silent-running cooling fans:** ideal for TV studios and opera houses
- **Electronic thermal management system:** ensures maximum performance of the system without any risk of overheating
- **Bodywork:** strong sheet metal construction for durability
- **Moving parts:** smooth at all times, even when hot
- **Captive knobs and handles:** additional security when working at height or in transit
- **Easy access to all parts:** easy cleaning and maintenance

Picture:1166

DSEN237_1166WW - 18/05/2017

Robert Juliat reserves the right to change or alter any of the items detailed on this page, to increase or improve manufacturing techniques without prior notice.

Robert Juliat S.A.S., 32 rue de Beaumont, 60530 Fresnoy-en-Thelle - France
Telephone : +33 (0)3 44 26 51 89 - fax : +33 (0)3 44 26 90 79 - info@robertjuliat.fr
www.robertjuliat.com



ROBERT JULIAT

Source

- **Lamp type:** LED
- **Power:** 250 W

LED specifications	Power *	Lumen output*	Colour temperature*	Life*	CRI* (min)
SUHD60 V2 WW (RJ / Osram)	250 W	17 500 lm	3200K	46 000 h	92

(*) manufacturer's data

Optics

Characteristics

- **Type:** Zoom
- **Beam range:** 10,5° to 22,5°
- **Focal length:** 184 - 374 mm

Gel filter

- **Shape:** Circle
- **Standard size:** 165 mm (6.5 in)

Gobo

- **Size:** A
- **Material:** Metal
Glass



Photometrics

with SUHD60 V2 WW (RJ / Osram) source

• Optics @ 10.5°

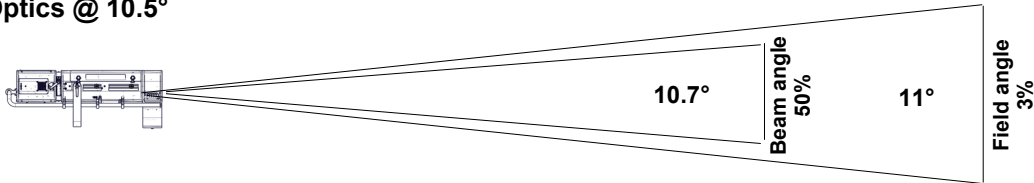

Beam intensity
202 800 cd

Field lumens
4 300 lm

Efficacy
14 lm/W

CCT
3 140 K

CRI
93

Distance	5 m	10 m	15 m	20 m	25 m	30 m
Diameter	1 m	1.9 m	2.9 m	3.9 m	4.8 m	5.8 m
Illumination	8 200 lux	2 050 lux	910 lux	510 lux	330 lux	230 lux
Distance	15 ft	35 ft	50 ft	65 ft	80 ft	100 ft
Diameter	2.9 ft	6.7 ft	9.6 ft	12.5 ft	15.4 ft	19.3 ft
Illumination	910 fc	170 fc	85 fc	49 fc	32 fc	21 fc

• Optics @ 22.5°

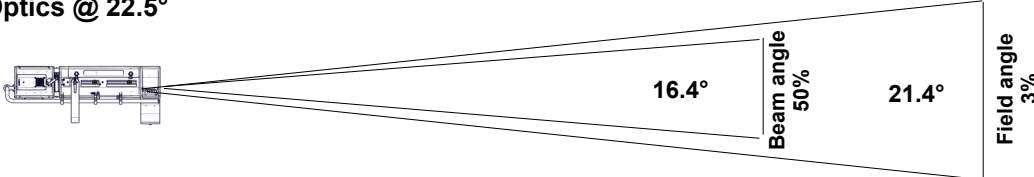

Beam intensity
85 700 cd

Field lumens
5 480 lm

Efficacy
18 lm/W

CCT
3 160 K

CRI
92

Distance	5 m	10 m	15 m	20 m	25 m	30 m
Diameter	1.9 m	3.8 m	5.7 m	7.6 m	9.4 m	11.3 m
Illumination	3 450 lux	860 lux	390 lux	220 lux	140 lux	100 lux
Distance	15 ft	35 ft	50 ft	65 ft	80 ft	100 ft
Diameter	5.7 ft	13.2 ft	18.9 ft	24.6 ft	30.2 ft	37.8 ft
Illumination	390 fc	70 fc	35 fc	21 fc	14 fc	9 fc

Remote control

- **Data protocol:** USITT DMX512-A
RDM / Art-Net / sACN

- **Data IN connector:** 5 pins XLR male
- **Data OUT connector:** 5 pins XLR female



• DMX chart:

Mode 1 (1 channels)	Mode 2 (4 channels)	Mode 3 (5 channels)	Mode 4 (5 channels)
Dimmer	Dimmer	Dimmer	Warm White
	Dimmer fine	Dimmer fine	Warm White fine
	CCT	CCT	Cool White
	Strobe	Strobe	Cool White fine
		Dimmer master	Strobe

Dimensions and weight

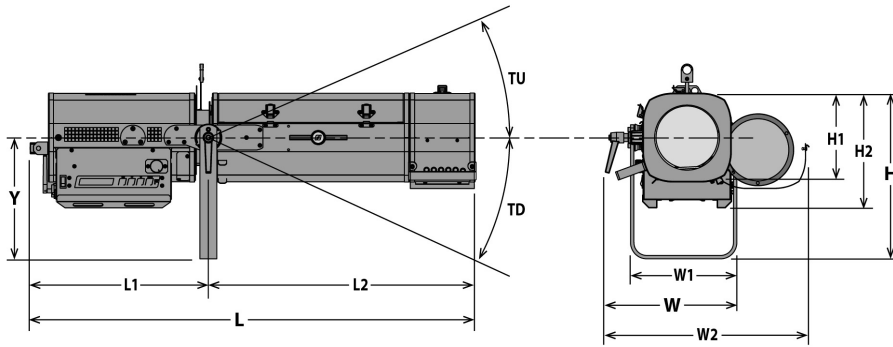

Weight: 20.5 kg (45.1 lbs)

Height	Length	Width	Yoke	Tilt
H= 387 mm (15.2 in)	L= 1045 mm (41.1 in)	W= 321 mm (12.6 in)	Y= 283 mm (11.1 in)	TU= 51°
H1= 208 mm (8.2 in)	L1= 418 mm (16.5 in)	W1= 249 mm (9.8 in)		TD= 65°
H2= 268 mm (10.6 in)	L2= 627 mm (24.7 in)	W2= 490 mm (19.3 in)		

Shipping

- **Weight :** kg (0 lbs)
- **Volume :** .17 m³ (6 ft³)

Installation

- **Minimum distance to illuminated surface:** 0.6 m (1.8 ft)
- **Operating position:**

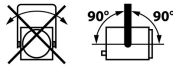

Warranty

- **Period: 2 years**
See General Sales Condition on website

Approvals



Construction

- **Housing:** Steel sheet - Aluminium
- **Colour:** Black
- **Cooling:** Low noise variable fan
- **Maximum ambient temperature (Ta):** 40°C (104°F)
- **Maximum case temperature (Tc):** 70°C (158°F)
- **Total heat dissipation:** 1 126 BTU/h
- **Protection rating:** 20

Electrical compatibility

- 220/230 V - 50 Hz
- 245 V - 50 Hz
- 110/120 V - 60 Hz
- 208 V - 60 Hz
- 220 V - 60 Hz
- 100 V - 50 Hz
- 100 V - 60 Hz
- Selector: automatic detection

Power input



- **Type:** removeable power cord with Neutrik powerCON TRUE1 connector (included)
- **Cable:** H07RNF 3G1.5
- **Length:** 3 m (9,8 ft)
- **Power connector:** CEE 7/7 (2P+E NF/Schuko)

Power consumption

Voltage	Frequency	Current	Power	Power factor
230 V	50 Hz	1.5 A	330 W	0,96
120 V	60 Hz	2.8 A	330 W	0,9
100 V	60 Hz	3.3 A	330 W	0,9



Power Supply Unit

- **PSU:** Internal - Electronic PSU - Flicker free with PFC
- **Control:** Local / DMX
- **Protection:** Mains: 4A 1P1D breaker - UL /
- **Power thru:** Neutrik powerCON TRUE1 - Maximum of 10 units (230 V) / 5 units (120 V)











Model

1166WW	LED 300 W Followspot - 1166WW Roxie - Warm White - 10,5/22,5°
---------------	---

Options

W-DMX/Z	W-DMX wireless DMX	
FC1124	Flight-case for Ultra Compact range / GT stand - Dim: 1210x600x560mm - Poids: 35 Kg	

Accessories

IS750	Full closing iris with holder - Weight: ,35 Kg 1 included	
PF1114	Ø165 mm metal filter holder 6 included	
SGUX	Universal "A" size gobo-holder (metal, glass, frosted glass) 1 included	
M165TP	6 ways "push/pull" colour changer - Weight: 2,09 Kg 1 included	
GT1000	Tripod stand - SWL: 40 Kg - max. height: 1550 mm - Weight: 9,27 Kg	
GT800	Tripod stand - SWL: 40 Kg - max. height: 1550 mm - Weight: 7,98 Kg	
T4000	Followspot mount for Ø50mm pipe (suspension or overhead) - SWL= 100 Kg - Weight: 4,88 Kg	
VD120	120x120mm frosted glass	
Kit TELRAD	Telrad followspot sight with raiser and universal mounting kit - Weight: 1,23 Kg	
SDUP	Followspot cue sheet holder with universal mounting kit	
FC1124/S	Flight-case for Ultra Compact range / GT stand - Weight: 35 Kg	
W/GT800	Set of 3 wheels for GT800/1000 stand - Weight: 2,33 Kg	